







### AXIS

## FAS120 VLD/G

The Axis FAS120 VLD/MLG corner fireplace combines expansive flame views with refined European design, creating a bold feature within contemporary interiors. Built with durable internal cast iron liners for enhanced heat retention, the tapered firebox base removes the need for a log pan, supporting a cleaner appearance and simplified maintenance.

-  Steel Fireplace with Cast Iron Liners
-  Includes Fire Grate and Ash Pan
-  High Performance Air Flow System
-  Crafted in France
-  Optional Outdoor Air Kit

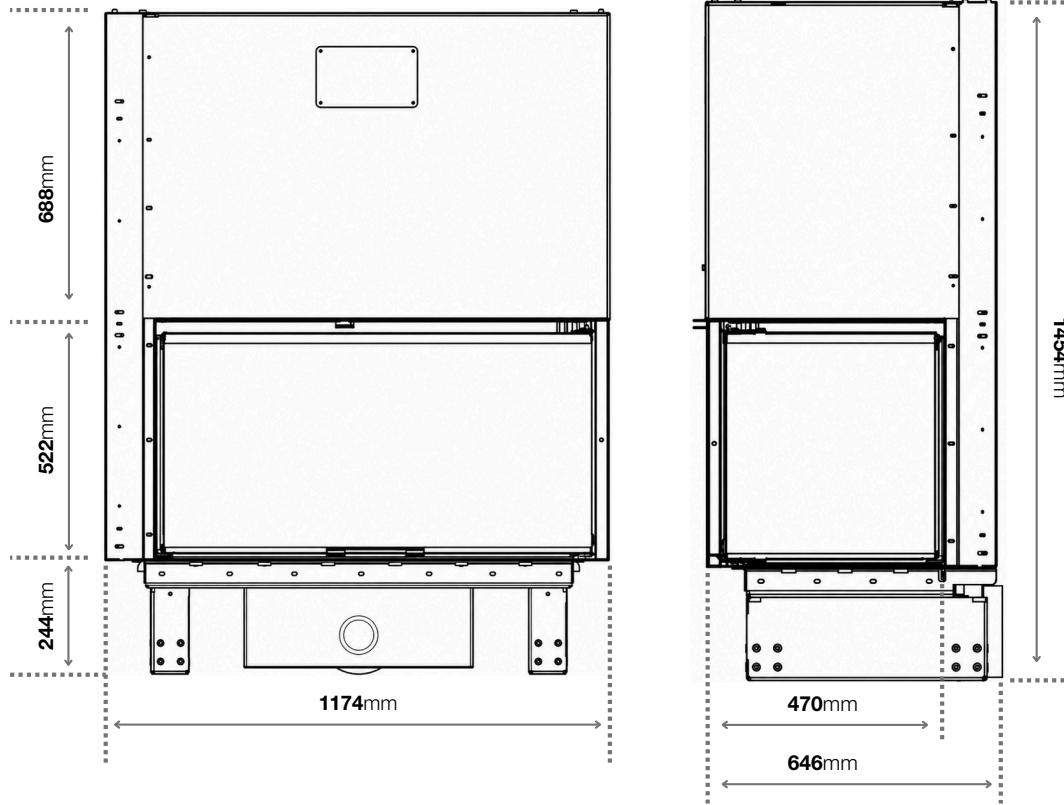

<b>MATERIAL</b>	Steel firebox construction, grooved cast iron internal back panels, and black silk-screen printed ceramic glass.
<b>KW OUTPUT / CAPACITY*</b>	22.5kW
<b>FACADE</b>	Clean frame-less design (trim options available)
<b>GLASS DOOR</b>	Lift and swing door
<b>GLASS VIEWING AREA</b>	Front: 973mm W x 474mm H / Side: 441mm W x 474mm H
<b>MINIMUM FLUE HEIGHT</b>	5.4
<b>FLUE SIZES</b>	230 (inner), 280, 330 mm (outer)
<b>OUTSIDE AIR KIT</b>	Optional extra - recommended for well insulated homes Required for 6 star or above rated homes
<b>HOT AIR TRANSFER KIT</b>	Optional extra - transfer heat to other rooms
<b>WARRANTY</b>	10 years on firebox (heating element)
<b>WEIGHT</b>	290kg

**Hearth & Clearance Guide**

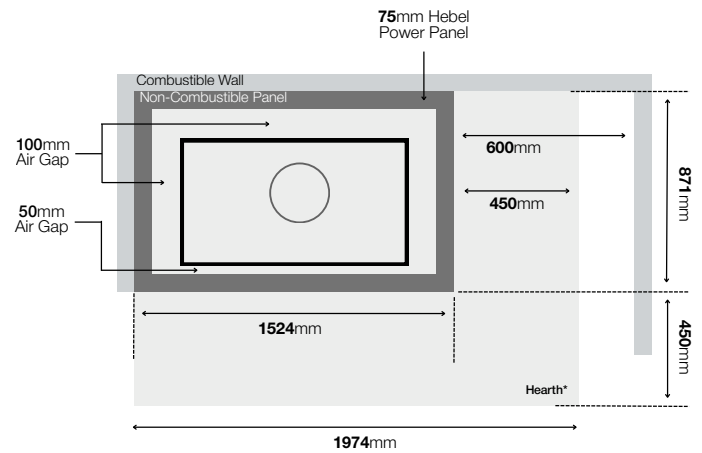

\*Hearth must be a minimum of 75mm thick

\*Heating capacity of the following appliances are a guide only and refers to areas with 2.4m ceilings and 6 or more star rated buildings. Heating output may vary depending on factors such as characteristics, quality of insulation, type of firewood used and climate zone. \*\* See warranty section in the installation manual for further details. \*\*\* Refer to the Installation Manual for full hearth dimensions and clearances.

**Disclaimer:** E&OE Images and diagrams are for illustration purposes only. Please note that all product measurements provided are approximate and may vary by 1-5 mm. Sculpt reserves the right to change these specifications without prior notice. This information does not replace the installation manual which provides more in depth information. Must be installed in a full masonry enclosure as per Australian & New Zealand standards AS/NZS 2918:2001.  
All rights retained © Copyright 2026 Sculpt Fireplace Collection (ABN: 48 107 321 719)